

CATV Fiber Splitter

FEATURES

- Industry-standard bulkhead style
- LGX-style available
- Highest splitter densities to maximize rack space
- Flexible and scalable platforms
- Rugged BUT lightweight packaging for solid protection and durability
- Full bend radius protection throughout modules
- Many input/output options for easy integration
- SC, LC and FC connector/adaptor options



APPLICATION

- FTTx Deployments (GPON/BPON/EPON)
- CCTV/CATV Links
- Access/Metro Networks

SPECIFICATIONS

Parameters	Values
Operating Wavelength	1260 ~ 1650 nm
Fiber Type	G657A2
Return Loss	>50 UPC or >55 APC dB
Directivity	>55 dB
Input Length	>1.0 m
Output Length	>1.0 m
Operational Temperature	-40°C ~ +85°C
Storage Temperature	-40°C ~ +85°C

SPLITTER SPECIFICATIONS

Parameter Unit	1 x 2	2 x 2	1 x 4	2 x 4	1 x 8	2 x 8	1 x 16	2 x 16	1 x 32	2 x 32	1 x 64	2 x 64	Unit
Insertion Loss	≤3.8	≤4.1	≤7.1	≤7.4	≤10.2	≤11.2	≤ 13.5	≤ 14.3	≤ 16.5	≤ 17.3	≤ 19.5	≤ 20.7	dB
Uniformity	≤0.6	≤0.8	≤0.6	≤0.8	≤ 0.8	≤ 1.5	≤ 1.2	≤ 2.0	≤ 1.5	≤ 2.5	≤ 2.5	≤ 2.5	dB
PDL	≤0.15	≤0.2	≤0.15	≤0.2	≤ 0.25	≤ 0.3	≤ 0.3	≤ 0.4	≤ 0.3	≤ 0.4	≤ 0.3	≤ 0.4	dB

FIBER DESIGN

Fiber Type		
Cable Colour	Input	9/125 m SMF-28e
	Output	Yellow or White
Pigtail Type	Input	Yellow or White (Blue, Orange, Green Brown, Grey, White, Red Black)*
	Output	Loose tube
Connector Type		Loose tube
		FC/SC/LC

PLC MINI SPLITTER

Parameters	1x2	2x2	1x4	1x8	2x4	2x8	1x16	1x32	2x16	2x32	1x64	2x64
Package (Length)		40.0mm				50.0mm			60.0mm		60.0mm	
Dimension (Width)		4.0mm				7.0mm			7.0mm		12.0mm	
(Height)		4.0mm				4.0mm			4.0mm		4.0mm	

PLC 0.9MM MODULE TYPE

Parameters	1x2	1x4	1x8	1x16	1x32	1x64
Package (Length)		60.0mm		60.0mm		100mm
Dimension (Width)		7.0mm		12.0mm		40mm
(Height)		4.0mm		4.0mm		6.0mm

PLC MODULE TYPE

Parameters	1x2	1x4	1x8	1x16	1x32	1x64
Package (Length)		100.0mm			120.0mm	
Dimension (Width)		80.0mm			80.0mm	
(Height)		10.0mm			18.0mm	

PLC LGX MODULE TYPE

Parameters	1x2			1x4			1x8		
	Type A	Type B	Type C	Type A	Type B	Type C	Type A	Type B	Type C
Package (Length)	155.0mm	90.0mm	117.0mm	155.0mm	90.0mm	117.0mm	155.0mm	170.0mm	117.0mm
Dimension (Width)	129.0mm	88.0mm	182.0mm	129.0mm	88.0mm	182.0mm	129.0mm	88.0mm	182.0mm
(Height)	29.0mm	26.0mm	44.0mm	29.0mm	26.0mm	44.0mm	58.0mm	52.0mm	44.0mm

PRODUCT DIAGRAM

Type A

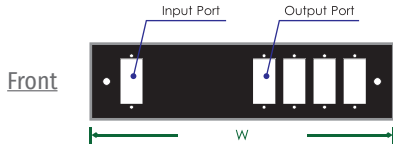

Type B

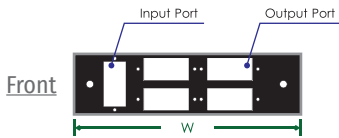

Type C

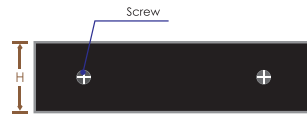
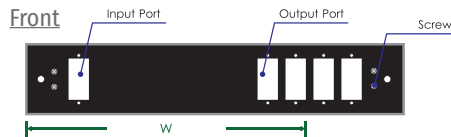

Side



PLC RACK MOUNT TYPE

Parameters	1X16	1X32	1X64
Package (Length)		251.0mm	
Dimension (Width)		482.5mm	
(Height)		43.6mm	

PRODUCT DIAGRAM

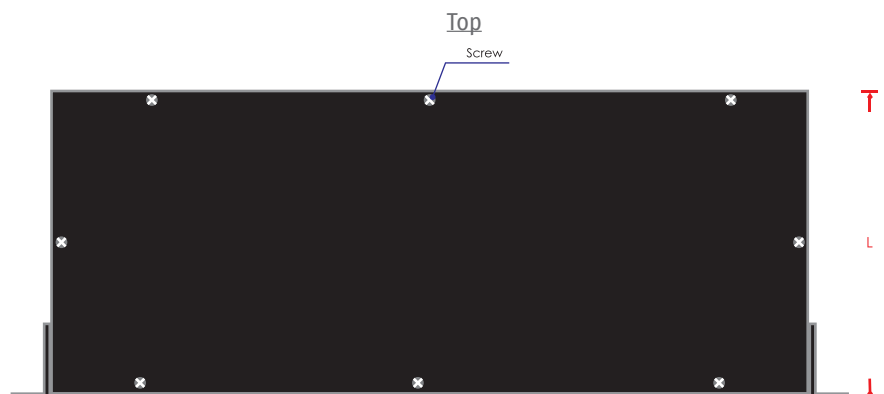
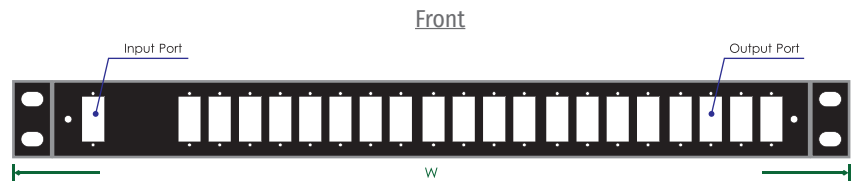
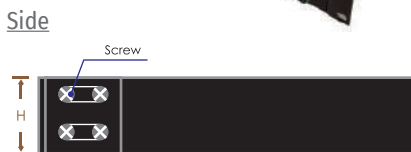

ORDERING INFORMATION

01 ~ 03 Type

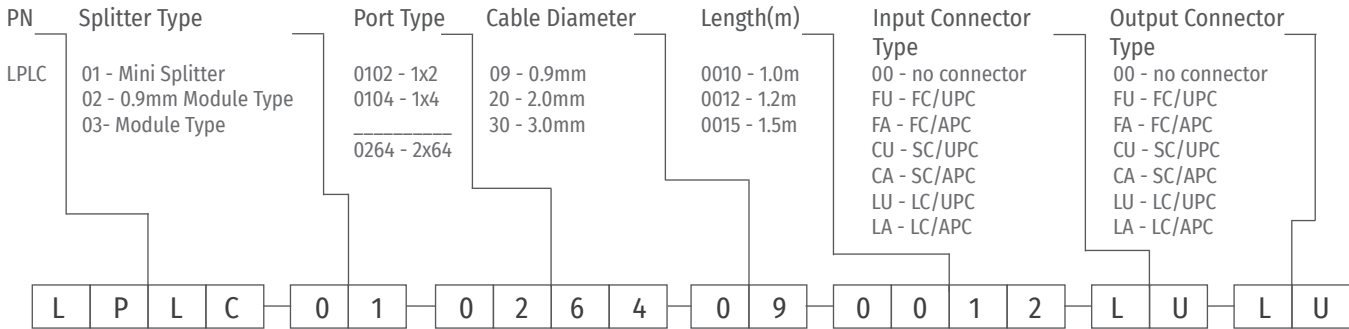

04 ~ 07 Type

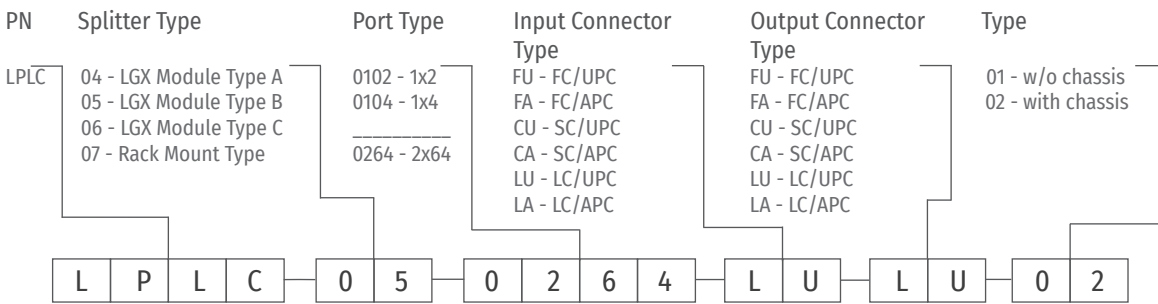

Remark: 1. Support LGX module type only.

* Ordering Code Example